

# **RIGOL**

## **Application Note**

### **RX1000 RF Demo Kit**

**Sep. 2013**

**RIGOL Technologies, Inc.**



# Guaranty and Declaration

## Copyright

© 2013 RIGOL Technologies, Inc. All Rights Reserved.

## Trademark Information

**RIGOL** is a registered trademark of RIGOL Technologies, Inc.

## Publication Number

APG02101-1110

## Notices

- **RIGOL** products are protected by patent law in and outside of P.R.C.
- **RIGOL** reserves the right to modify or change parts of or all the specifications and pricing policies at company's sole decision.
- Information in this publication replaces all previously corresponding material.
- **RIGOL** shall not be liable for losses caused by either incidental or consequential in connection with the furnishing, use or performance of this manual as well as any information contained.
- Any part of this document is forbidden to be copied or photocopied or rearranged without prior written approval of **RIGOL**.

## Product Certification

**RIGOL** guarantees this product conforms to the national and industrial standards in China as well as the ISO9001:2008 standard and the ISO14001:2004 standard. Other international standard conformance certification is in progress.

## Contact Us

If you have any problem or requirement when using our products or this manual, please contact **RIGOL**.

E-mail: [service@rigol.com](mailto:service@rigol.com)

Websites: [www.rigol.com](http://www.rigol.com)

# Contents

- Guaranty and Declaration ..... I**
- Product Overview..... 1**
- Hardware Modules ..... 2**
- To Control RX1000 Using PC Software ..... 3**
  - Software Installation ..... 3
  - System and Installation Requirements ..... 3
  - Installation Procedures ..... 3
  - To Connect RX1000..... 5
  - To Start the Software ..... 7
  - Interface Layout ..... 8
- To Control RX1000 Using DSG3000..... 10**
- Typical Applications ..... 11**
  - To Test the frequency conversion function of RX1000 ..... 11
  - To Test the Band-pass Filter Characteristics ..... 12
  - The Influence of the Performance of Amplifier on the System ..... 13
  - The Influence of the Performance of Filter on the System ..... 15
- Specifications..... 16**
- Accessories ..... 18**

---

## Product Overview

RX1000 RF Demo Kit (hereinafter referred to as RX1000) is a signal receiver kit released by **RIGOL** to demonstrate the DSG3000 series RF signal generator.

### **RX1000 features:**

- Energized by USB.
- Connected with PC for control through software.
- When connected with DSG3000, it can be controlled via the built-in control interface of DSG3000 without using the PC.
- The frequency of the DSG3000 output signal is converted to the down-frequency by “switches”. The down-frequency signal can be connected to the input port of the spectrum analyzer or the oscilloscope to be used for the learning, operation and demonstration.
- Provide 10 MHz reference signal output for easy clock synchronization with other devices.
- Provide 500 MHz and 1 GHz local oscillator signal outputs.
- Modular circuit design; provide interfaces for users to make separate measurement of any component; enable to replace any component.

## Hardware Modules

The appearance of RX1000 is as shown in Figure 1. The hardware modules of RX1000 include the filter, amplifier, mixer and VGA. The schematic diagram is as shown in Figure 2.

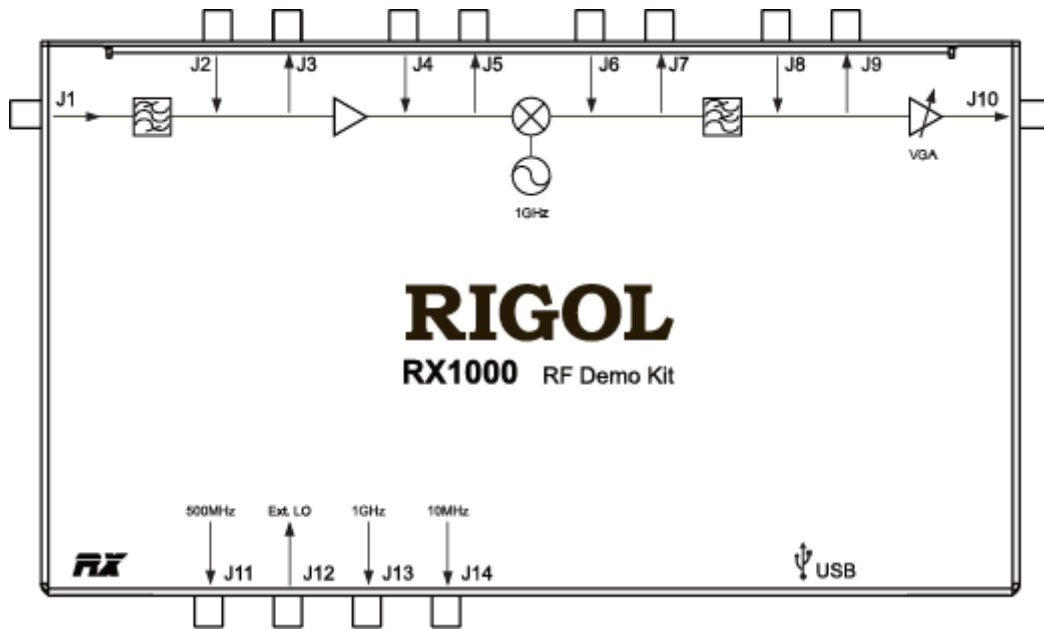

Figure 1 RX1000 Appearance

- USB port: used to connect the PC or RF signal generator (provide power for the modules and control the modules).
- J1, J2, J4, J6, J8: input RF signal.
- J3, J5, J7, J9, J10: signal output terminal.
- J11: output 500 MHz local oscillator signal.
- J12: input external local oscillator signal.
- J13: output 1 GHz local oscillator signal.
- J14: output 10 MHz reference signal.

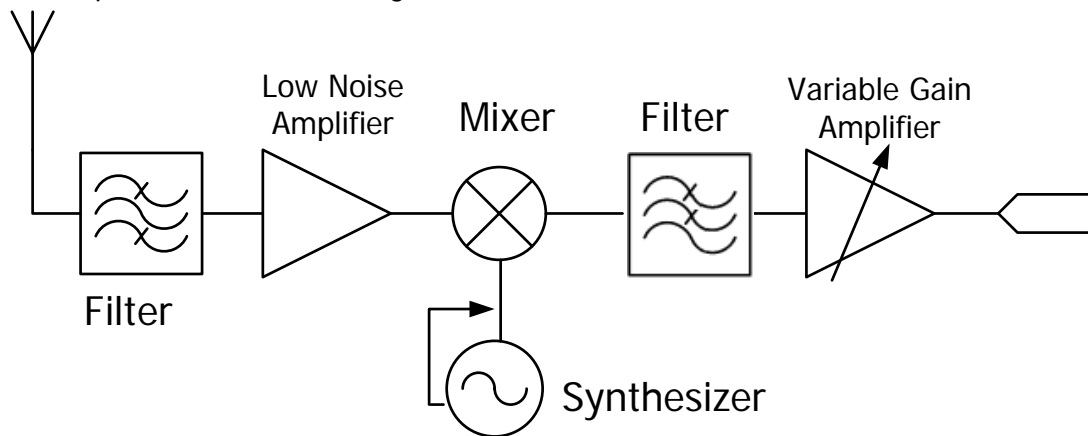

Figure 2 RX1000 Schematic Diagram

---

# To Control RX1000 Using PC Software

## Software Installation

When using RX1000 with the PC, you have to install the PC control software of RX1000.

## System and Installation Requirements

### 1. Hardware Configuration Requirements

- Processor: 1 GHz and greater
- Memory: 500 MB and greater
- Display: 1024×768 or higher resolution
- Hard Disk: 200 MB and greater

### 2. Running Environment

- Operation System: Windows XP (32-bit), Windows 7 (32-bit), Windows Vista (32-bit)
- PC administrator privileges: use the administrator account to log into the PC
- The **RIGOL** common PC software (Ultra Sigma 00.01.05.05 or higher version) has been installed.

## Installation Procedures

1. Before installing the software, install Ultra Sigma 00.01.05.05 or higher version. For the installation procedures, refer to the related manual of Ultra Sigma.
2. **RIGOL** provides the installation package (in the CD in the product package) of the PC control software of RX1000. Double-click the **RX1000 setup.exe** file to enter the interface as shown in the figure below and follow the instructions to finish the installation.



3. Click "Next" and start to install the software.
4. The installation process finishes as shown in the figure below. At this point, you have successfully installed the PC control software of RX1000 and the shortcut named "RX1000 RF Demo Kit" is displayed on the desktop.





## To Connect RX1000

Connect RX1000 and the PC using USB cable. At this point, the “New Hardware Wizard” is displayed on the PC. Please install the “USB Test and Measurement Device” driver following the instructions in the wizard.

The steps are as follows:

1. Select “Install from a list or specific location (Advanced)” and click “Next”;

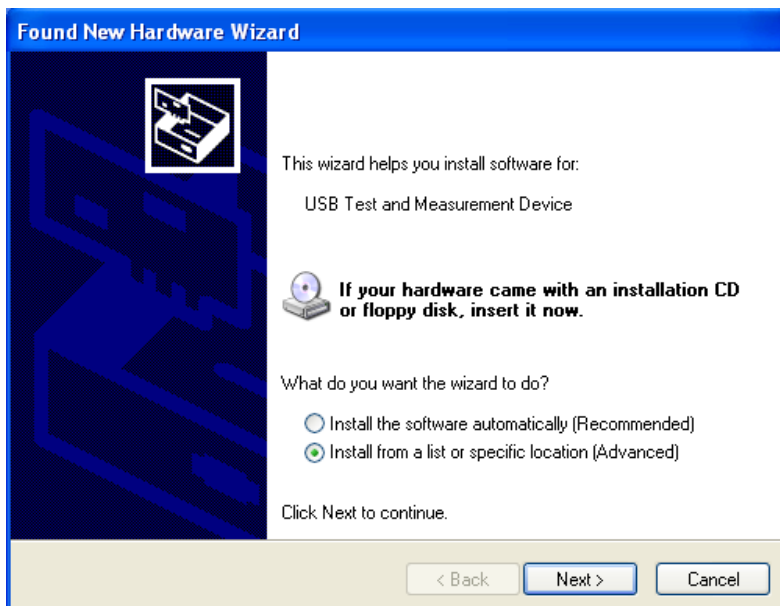

2. Select “Don’t search. I will choose the driver to install” and click “Next”;

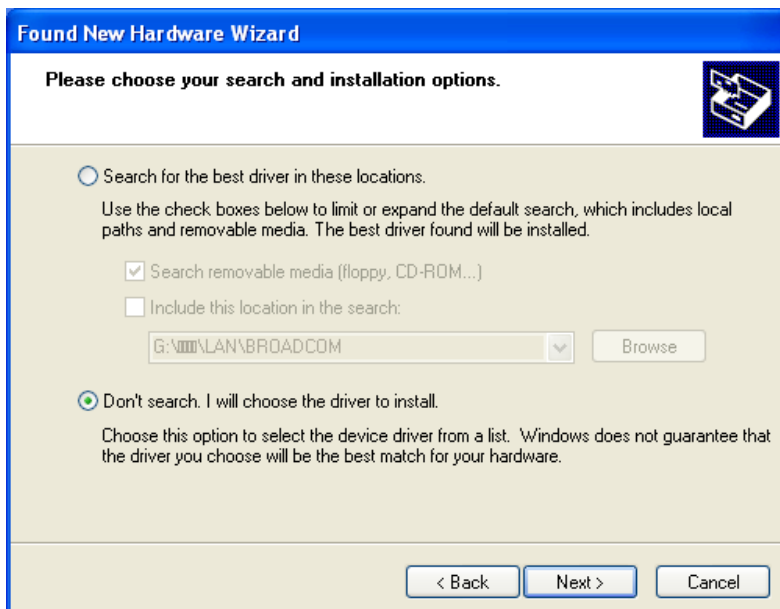

3. Select “USB Test and Measurement Device” and click “Next”;

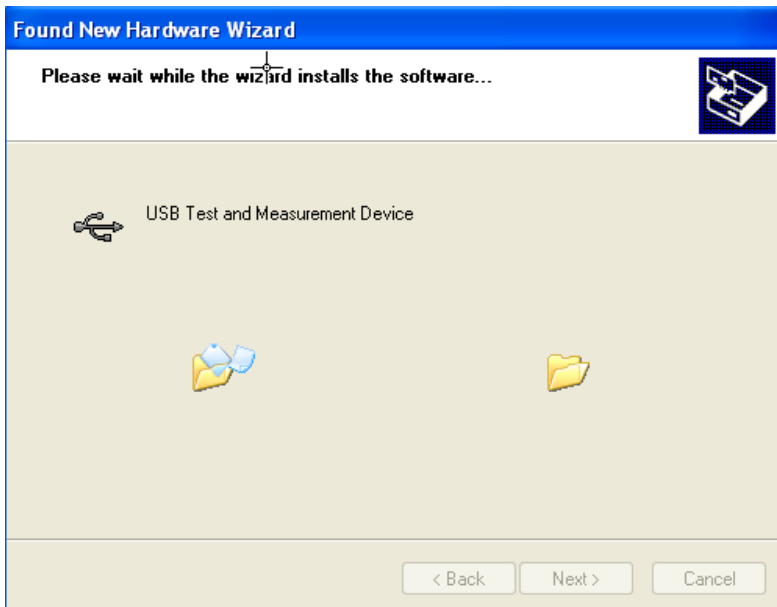
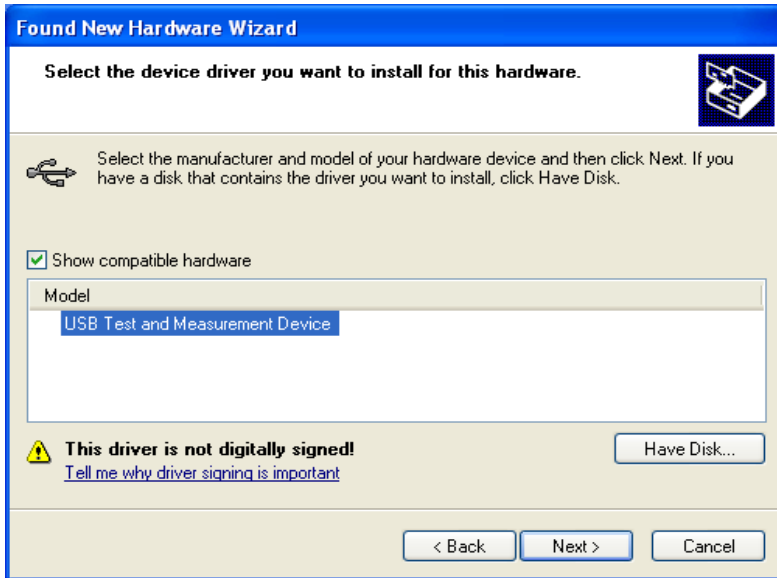

- 4. Click "Finish" after the installation is finished.



## To Start the Software

After the PC control software of RX1000 is successfully installed, you can start the software via the following two methods.

### 1. Via the [Start] menu or the shortcut on the desktop

Click [Start] → [All Programs] → [RIGOL Technologies, Inc] → [RX1000 RF Demo Kit] → [RX1000 RF Demo Kit] or double-click the shortcut named “RX1000 RF Demo Kit” on the desktop to enter the software interface.

**Note:** the communication between the software and RX1000 cannot be built automatically via this method (even when the RX1000 is connected to the PC). The connection status is  when the software is started. You need to build the communication between the software and RX1000 manually by referring to the introductions in “**Interface Layout**”.

### 2. Via Ultra Sigma

- Connect RX1000 with the PC using the USB cable provided with the accessories;
- Start the Ultra Sigma and search for the RX1000 connected;
- As shown in the figure below, right-click the resource name of the RX1000 connected and select “RX1000 RF Demo Kit” to enter the software interface.

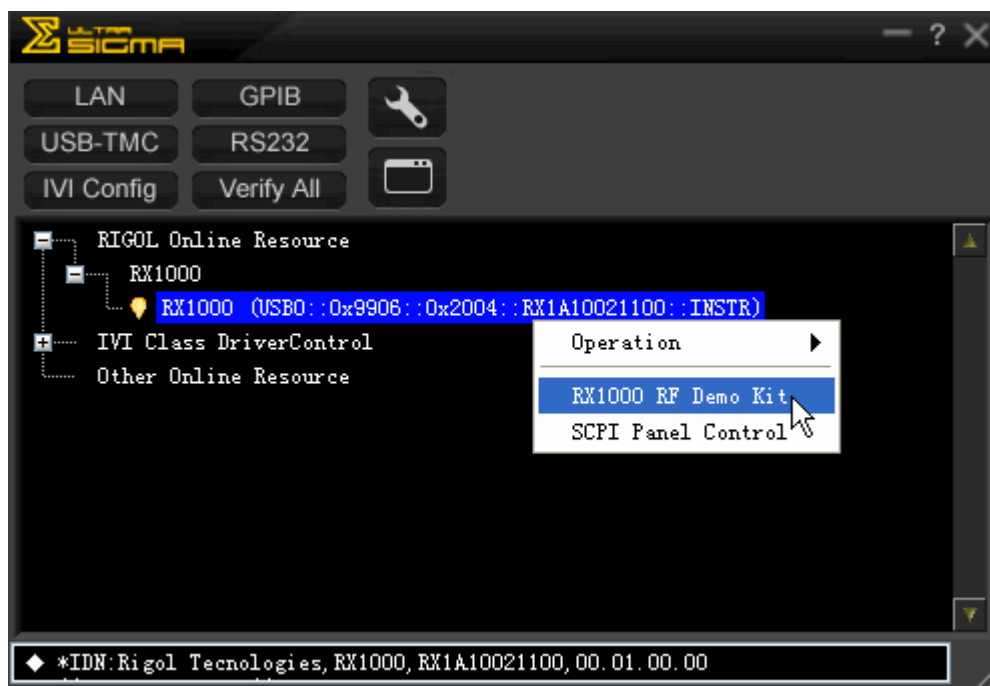



Figure 3 Start the Software via Ultra Sigma

**Note:** the communication between the software and RX1000 can be built automatically via this method (make sure that your PC has been connected with RX1000). The connection status is  when the software is started.

## Interface Layout

The interface of the PC control software of RX1000 is as shown in the figure below.

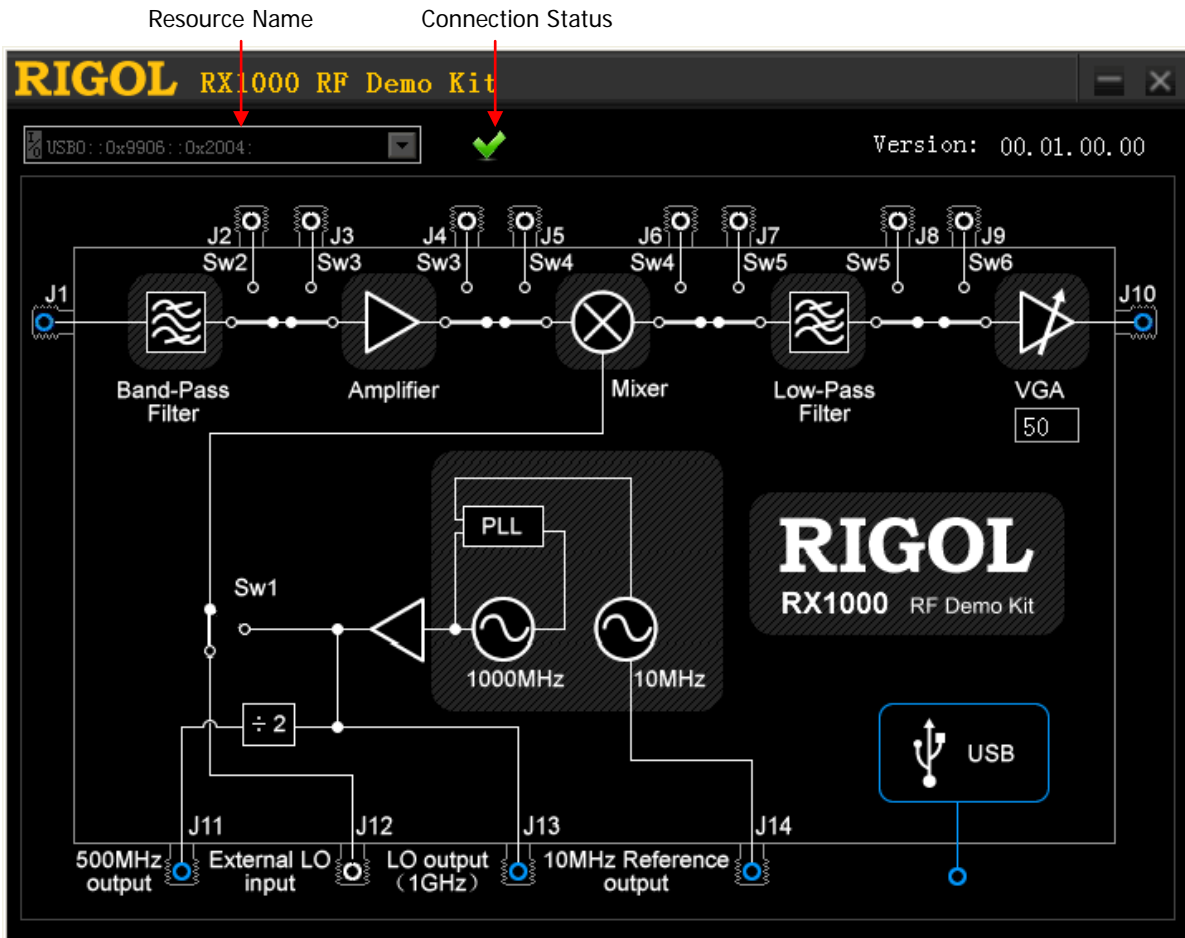



Figure 4 Interface Layout of the PC Control Software

### 1. Resource Name and Connection Status

When starting the software via Ultra Sigma, the software displays the resource name automatically and the dropdown box is grayed out and disabled. At this point, the connection status is  denoting that the connection is successful. When starting the software via the

**[Start]** menu or shortcut on the desktop, the connection status is ; you need to click the dropdown box and select the resource name of the RX1000 connected to build the communication between the software and RX1000 manually. It takes some time (several seconds) for the software to search the resources and please wait for the resource list patiently. When multiple devices are connected to the PC, the resource names of all the devices will be displayed in the dropdown list and please select the resource name started with USB0::0x9906::0x2004 (all the resource names of RX1000 start with this character string).



## 2. Control Switches

After the software and RX1000 are successfully connected, you can control RX1000 via the software interface. There are six switches (Sw1, Sw2, Sw3, Sw4, Sw5 and Sw6) on the software interface and you can click the corresponding switch to control its state.

- Sw1: when J12 is connected, connect the external local oscillator signal input from the J12 terminal; when the J12 is disconnected, connect the internal 1 GHz local oscillator signal.
- Sw2: when J2 is connected, connect the signal input from the J2 terminal; when J2 is disconnected, amplify the signal passing through the band-pass filter or output it from the J3 terminal.
- Sw3: when J3 and J4 are connected, output signal from J3 or connect the signal input from the J4 terminal; when J3 and J4 are disconnected, amplify the signal passing through the band-pass filtering or the signal input from the J2 terminal.
- Sw4: when J5 and J6 are connected, output signal from J5 or connect the signal input from the J6 terminal; when J5 and J6 are disconnected, perform mixing on the signal passing through the amplifier or the signal input from J4 terminal.
- Sw5: when J7 and J8 are connected, output signal from J7 or connect the signal input from the J8 terminal; when J7 and J8 are disconnected, perform low-pass filtering on the signal passing through the mixer or the signal input from the J6 terminal.
- Sw6: when J9 is connected, output signal from J9; when J9 is disconnected, adjust the amplitude of the signal passing through the low-pass filter or the signal input from the J8 terminal and then output it via J10.

## 3. Adjust VGA

Use the mouse to click the text box under the VGA on the software interface and modify the value (gain code) in it. At this point, you can adjust the amplitude of the signal output from the J10 terminal (output voltage gain). The gain code of VGA can be set from 0 to 255.

Output linear voltage gain ( $A_v$ ) and gain code ( $G_c$ ) satisfy the following relationship:

$$A_v = G_c \times Veinier \times (1 + (PG - 1) \times MSB)$$

Therein,

$$Veinier = 0.055744 \text{ V/V};$$

$$PG = 7.079458 \text{ V/V};$$

When  $G_c$  is from 0 to 127 (low gain mode),  $MSB = 0$ ;

When  $G_c$  is from 128 to 255 (high gain mode),  $MSB = 1$ .

## To Control RX1000 Using DSG3000

When using RX1000 with the DSG3000 series, you can control RX1000 using the built-in control interface of DSG3000 without using the PC and PC control software.

1. Connect RX1000 and DSG3000 using the USB cable provided with the accessories.
2. Press **LF** **AUX** at the front panel of the DSG3000 and press **RX1000** to open the control interface as shown in the figure below.

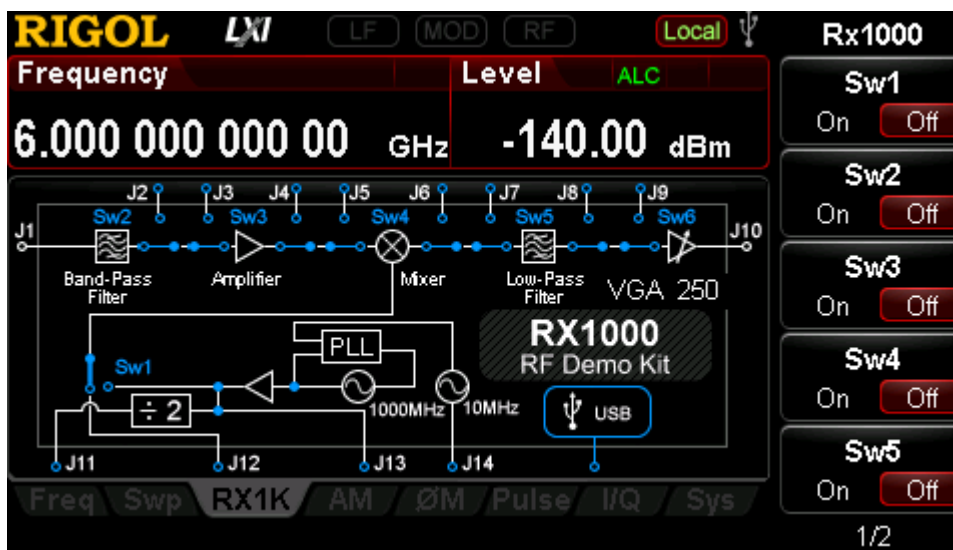

Figure 5 Built-in RX1000 Control Interface of DSG3000

3. You can use the menu at the right to control the state of the six switches respectively. In addition, you can also use the **VGA** menu to adjust the amplitude of the signal output from the J10 terminal. For more information, please refer to “**Adjust VGA**”.

## Typical Applications

### To Test the frequency conversion function of RX1000

#### Operation Steps:

1. Connect the DSG3000 series RF signal generator and RX1000 using USB cable; connect the J1 terminal of the RX1000 and the RF output interface of the DSG3000 using an N-SMA cable; connect the J10 terminal of the RX1000 and the RF input interface of the spectrum analyzer using another N-SMA cable as shown in Figure 6.

**Explanation:** when using the PC software to control RX1000, you can connect the PC and RX1000 using USB cable. Then according to the above method to connect the RF signal generator, the RX1000 and the spectrum analyzer using N-SMA cables.

2. Configure the status of each switch via the built-in RX1000 control interface of DSG3000.

Switch	Control Status	Switch Status
Sw1	Disconnect J12 and connect J13	On
Sw2	Disconnect J2	Off
Sw3	Disconnect J3 and J4	Off
Sw4	Disconnect J5 and J6	Off
Sw5	Disconnect J7 and J8	Off
Sw6	Disconnect J9	Off

3. Output a 950 MHz signal from the RF output interface of the DSG3000 and input the signal from the J1 terminal of the RX1000.
4. Set the measurement parameters on the spectrum analyzer to get a 50 MHz signal.

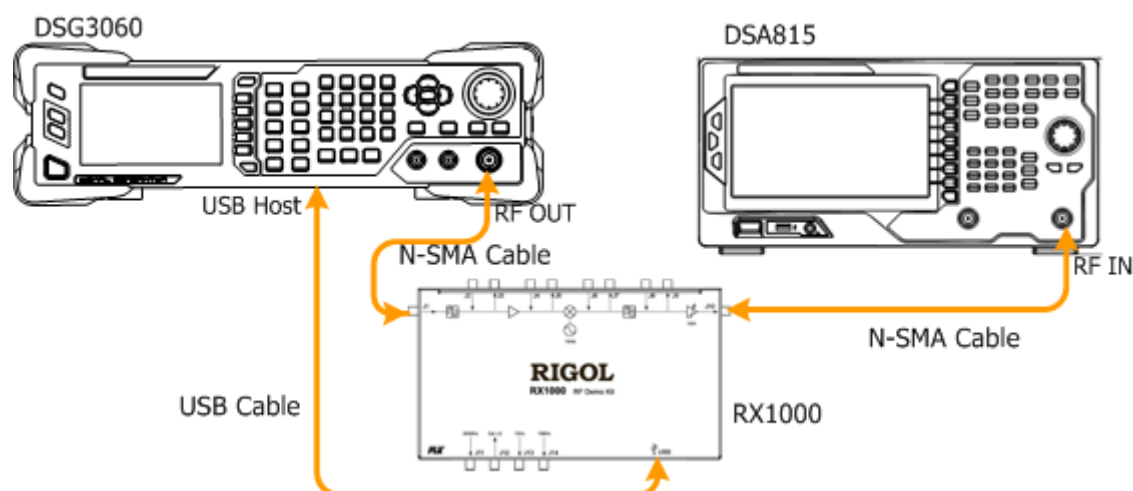

Figure 6 Test the frequency conversion function of the RX1000

## To Test the Band-pass Filter Characteristics

### Operation Steps:

1. Connect the DSG3000 series RF signal generator and RX1000 using USB cable; connect the J1 terminal of the RX1000 and the RF output interface of the DSG3000 using an N-SMA cable; connect the J3 terminal of the RX1000 and the RF input interface of the spectrum analyzer using another N-SMA cable as shown in Figure 7.

**Explanation:** when using the PC software to control RX1000, you can connect the PC and RX1000 using USB cable. Then according to the above method to connect the RF signal generator, the RX1000 and the spectrum analyzer using N-SMA cables.

2. Configure the status of each switch via the built-in RX1000 control interface of DSG3000.

Switch	Control Status	Switch Status
Sw1	Ignore	Ignore
Sw2	Disconnect J2	Off
Sw3	Connect J3 and J4	On
Sw4	Ignore	Ignore
Sw5	Ignore	Ignore
Sw6	Ignore	Ignore

3. Configure the parameters (e.g. enable the RF output, set the RF frequency or amplitude and so on) on the RF signal generator. Output this signal from the RF output interface of the DSG3000 and then input the signal from the J1 terminal of the RX1000.
4. Set the measurement parameters on the spectrum analyzer to get the measurement results.

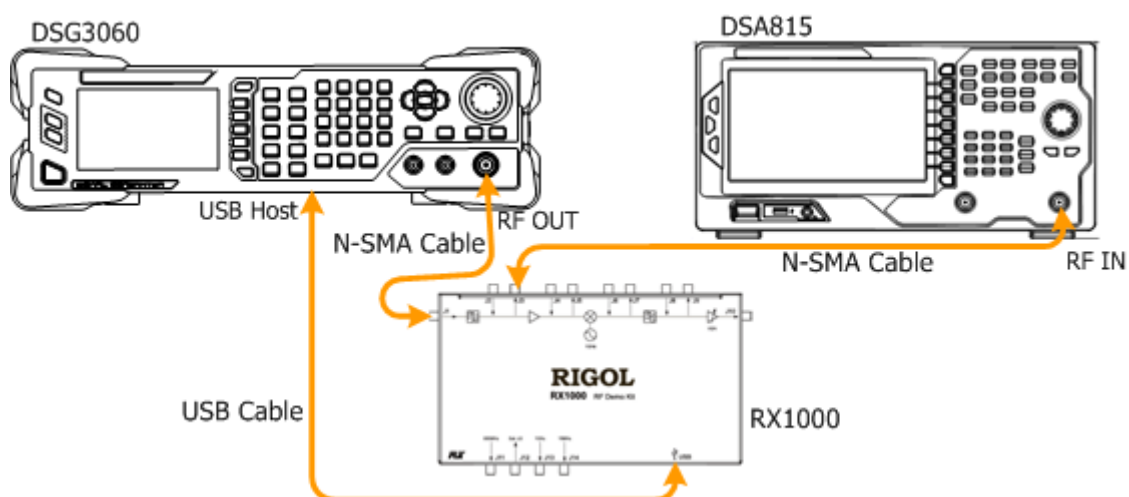

Figure 7 Test the Band-pass Filter Characteristics



## The Influence of the Performance of Amplifier on the System

### Operation steps:

1. Connect the DSG3000 series RF signal generator and RX1000 using USB cable; connect the J1 terminal of the RX1000 and the RF output interface of the DSG3000 using an N-SMA cable; connect the J10 terminal of the RX1000 and the RF input interface of the spectrum analyzer using another N-SMA cable; connect the amplifier to J3 and J4 using two SMA-SMA cables (to replace the internal amplifier of RX1000) as shown in Figure 8.

**Explanation:** when using the PC software to control RX1000, you can connect the PC and RX1000 using USB cable. Then according to the above method to connect the RF signal generator, the RX1000, the spectrum analyzer and the amplifier module.

2. Configure the status of each switch via the built-in RX1000 control interface of DSG3000.

Switch	Control Status	Switch Status
Sw1	Disconnect J12 and connect J13	On
Sw2	Disconnect J2	Off
Sw3	Connect J3 and J4	On
Sw4	Disconnect J5 and J6	Off
Sw5	Disconnect J7 and J8	Off
Sw6	Disconnect J9	Off

3. Configure the parameters (e.g. enable the RF output, set the RF frequency or amplitude and so on) on the RF signal generator. Output this signal from the RF output interface of the DSG3000 and then input the signal from the J1 terminal of the RX1000.
4. Set the measurement parameters on the spectrum analyzer to get the measurement results.

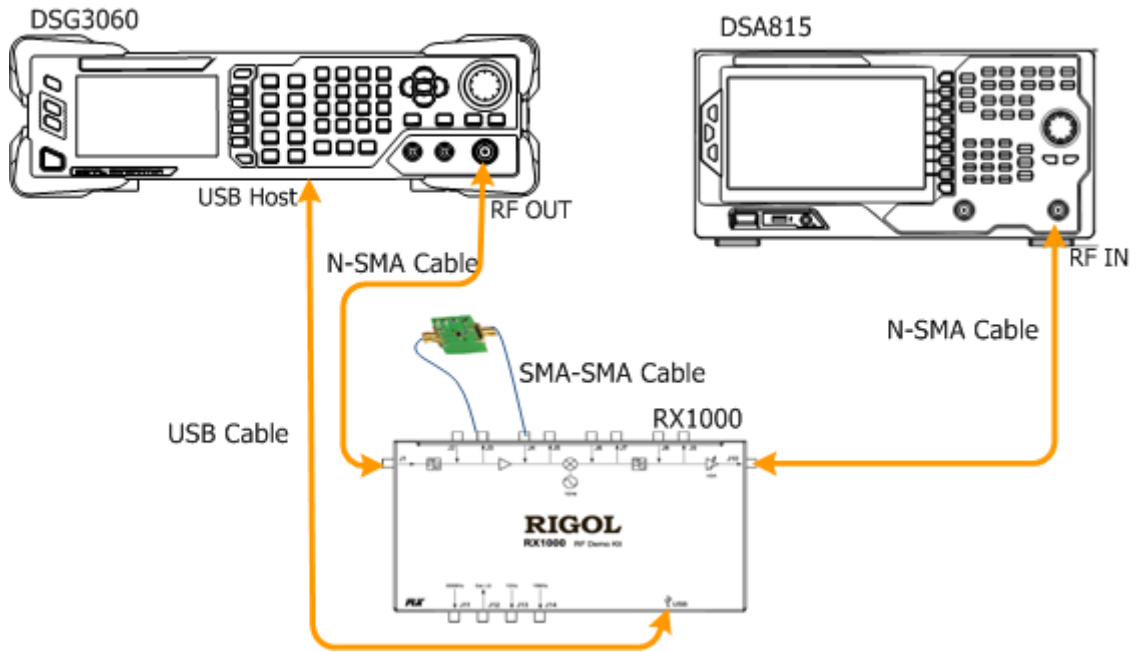

Figure 8 The Influence of the Performance of Amplifier on the System

## The Influence of the Performance of Filter on the System

### Operation Steps:

1. Connect the DSG3000 series RF signal generator and RX1000 using USB cable; connect the J1 terminal of the RX1000 and the RF output interface of the DSG3000 using an N-SMA cable; connect the J10 terminal of the RX1000 and the RF input interface of the spectrum analyzer using another N-SMA cable; connect the low-pass filter to J7 and J8 using two SMA-SMA cables (to replace the internal low-pass filter of RX1000) as shown in Figure 9.

**Explanation:** when using the PC software to control RX1000, you can connect the PC and RX1000 using USB cable. Then according to the above method to connect the RF signal generator, the RX1000, the spectrum analyzer and the filter module.

2. Configure the status of each switch via the built-in RX1000 control interface of DSG3000.

Switch	Control Status	Switch Status
Sw1	Disconnect J12 and connect J13	On
Sw2	Disconnect J2	Off
Sw3	Disconnect J3 and J4	Off
Sw4	Disconnect J5 and J6	Off
Sw5	Connect J7 and J8	On
Sw6	Disconnect J9	Off

3. Configure the parameters (e.g. enable the RF output, set the RF frequency or amplitude and so on) on the RF signal generator. Output this signal from the RF output interface of the DSG3000 and then input the signal from the J1 terminal of the RX1000.
4. Set the measurement parameters on the spectrum analyzer to get the measurement results.

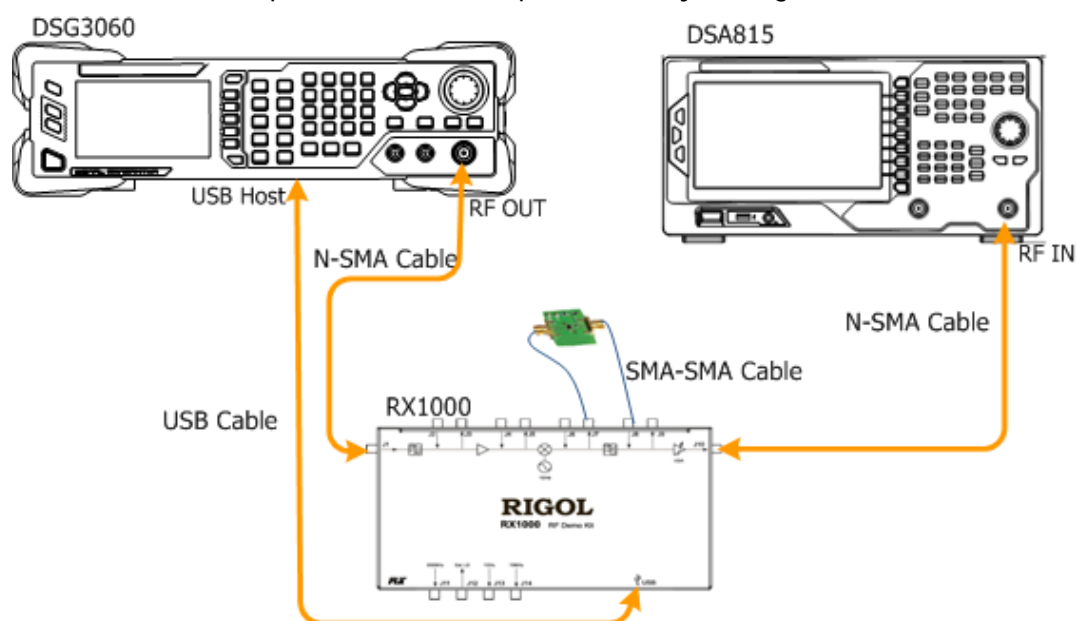

Figure 9 The Influence of the Performance of the Filter on the System

# Specifications

This section lists the specifications of RX1000. The specifications can be guaranteed under the following conditions: the temperature range is from 0°C to 45°C; the instrument has been warmed up for at least 30 minutes.

Parameter	Explanation
<b>Input Port</b>	
Input Frequency (Standard) (Expansion)	950 MHz $\pm$ 20 MHz 50 MHz to 1000 MHz
Input Power	$\leq$ 0 dBm
<b>Output Port</b>	
Output Frequency (Standard) (Expansion)	50 MHz $\pm$ 20 MHz DC to 1000 MHz
<b>Internal Local Oscillator Output</b>	
Output Frequency	500 MHz, 1000 MHz
Phase Noise	-98 dBc/Hz@10 kHz, Typical
<b>Reference Frequency</b>	
Frequency	10 MHz
Temperature Stability	$\pm$ 1 ppm (0°C to 45°C)
Aging Rate	$\pm$ 1 ppm/year
Output Power	>0 dBm
<b>Distortion</b>	
SHI	+40 dBm
IP3	+20 dBm
<b>Mixer</b>	
RF/LO Input Frequency Range	50 MHz to 1000 MHz
IF Output Frequency Range	DC to 1000 MHz
Local Oscillator Drive Power	+7 dBm
Insertion Loss	8 dB (Maximum)
<b>Band-pass Filter</b>	
Center Frequency	950 MHz
1dB Bandwidth	30 MHz
Insertion Loss	3.2 dB (Typical), 4.0 dB (Maximum)
In-band Flatness	0.8 dB (Typical), 1.5 dB (Maximum)
Restrain at Center Frequency $\pm$ 40 MHz	>40 dB
<b>Low-pass Filter</b>	
Stop Frequency	90 MHz
In-band Flatness	0.3 dB (Typical)
<b>Variable Gain Amplifier</b>	
-3 dB Bandwidth	750 MHz

Gain	-11 dB (Typical), 34 dB (Maximum)
NF	7 dB (Maximum Gain)
<b>Amplifier</b>	
Working Frequency	DC to 2 GHz
Gain	20 dB (Typical)
P1dB	> +5 dBm
NF	3.3 dB
<b>USB Interface</b>	
Port	B Socket
Protocol	1.1 Version
<b>Environment Temperature</b>	
Working Temperature	0°C to 45°C
Storage Temperature	-20°C to 70°C
Relative Humidity	<95%
<b>Others</b>	
Connector Type	SMA (JACK)
Port Input/output Impedance	50 $\Omega$
Power Consumption	1.5 W
Weight	0.7 kg

## Accessories

<b>Name</b>	<b>Specification &amp; Quantity</b>
RX1000 RF Demo Kit	1
USB Cable	1.5 m, 1
SMA-SMA Cable	100 mm, 3
N-SMA Cable	500 mm, 2
CD	Include PC control software installation program and application note, 1
Kit Package	1

To order the above accessories, please contact **RIGOL**.